

01.2024 r.



KATALOG PROFILI
STANDARDOWYCH

CATALOGUE OF STANDARD
PROFILES

ALIPLAST STANDARD
PROFILENVERZEICHNIS

Spis treści | Contents | Inhalt

1. Profile standardowe | Standard profiles | Standardprofile

- 1.1. Kątowniki równoramienne | Equal - L profiles | Winkelprofile Gleichschenklig | 03
- 1.2. Kątowniki nierównoramienne | Non equal - L profiles | Winkelprofile Ungleichschenklig | 04
- 1.3. Ceowniki | U-profiles | U-profile | 06
- 1.4. Rury okrągłe | Round tubes | Rundrohre | 08
- 1.5. Rury kwadratowe | Square tubes | Quadratrohre | 10
- 1.6. Rury prostokątne | Rectangular tubes | Vierkantrohre | 11
- 1.7. Pręty prostokątne | Flat bars | Flachprofile | 14
- 1.8. Pręty okrągłe | Round bars | Rundstangen | 16
- 1.9. Pręty kwadratowe | Square bars | Vierkantstange | 16
- 1.10. Teowniki | T-profiles | T-profile | 17

2. Profile specjalne | Special sections | Sonderprofile

- 2.1. Profile reklamowe | Profiles for advertising | Profile für die Lichtwerbung | 18
- 2.2. Profile do płyt poliwęglanowych | Profiles for polycarbonates | Profile zu Konstruktionen mit Polykarbonat | 20
- 2.3. Profile do central klimatyzacyjnych | Profiles for air conditioning | Klimazentralenprofile | 21
- 2.4. Profile do zabudów samochodowych | Profiles for trailers, semi-trailers | Fahrzeugbauprofile | 22
- 2.5. Profile elewacyjne | Elevation profiles | Elevationsprofile | 23
- 2.6. Profile fotowoltaiczne | Profiles for photovoltaics | Profile für die photovoltaik | 24
- 2.7. Profile do hal namiotowych | Profiles for tents | Zeltbauprofile | 25
- 2.8. Profile inne | Other profiles | Andere Profile | 26

1. Profile standardowe | Standard profiles | Standardprofile

1.1. Kątowniki równoramienne

Equal - L profiles
Winkelprofile Gleichschenklig

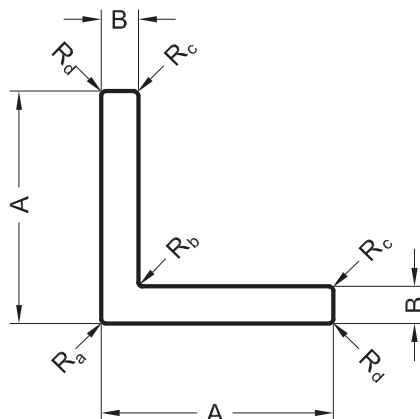

Lp.	Wymiar Dimension Abmessung		Promień Radius Radius				Obwód Perimeter Abwicklung	Masa Weight Gewicht	Nr matrycy Number of die Werkzeug Nr.
	A	B	Ra	Rb	Rc	Rd	mm	kg/m	
1	20	1,5	0,5	0,5	0,3	0,3	79,06	0,156	M1.90276
2	20	2	0,2	0,2	0,2	0,2	79,50	0,205	M1.90078
3	25	1,5	0,3	0,3	0,3	0,3	99,23	0,196	M1.90105
4	25	2	0,3	0,3	0,3	0,3	99,23	0,259	M1.90020
5	25	3	0,3	0,3	0,3	0,3	99,23	0,380	M1.90328
6	30	2	0,2	0,2	0,2	0,2	119,49	0,313	M1.90002
7	30	3	0,5	0,5	0,5	0,5	118,71	0,461	M1.90019
8	35	2	0,3	0,3	0,3	0,3	139,23	0,367	M1.90094
9	35	3	0,5	0,5	0,5	0,5	138,71	0,544	M1.90062
10	40	2	0,2	0,2	0,2	0,2	159,49	0,421	M1.90003
11	40	3	0,5	0,5	0,5	0,5	158,71	0,623	M1.90162
12	40	4	0,5	0,5	0,5	0,5	158,71	0,820	M1.90199
13	50	2	0,3	0,3	0,3	0,3	199,23	0,529	M1.90004
14	50	3	0,3	0,3	0,3	0,3	199,23	0,788	M1.90070
15	50	5	0,5	0,5	0,5	0,5	198,93	1,282	M1.90005
16	60	2	0,5	0,5	0,5	0,5	238,71	0,637	M1.90171
17	60	3	0,3	0,3	0,3	0,3	239,23	0,947	M1.90375
18	100	2	0,3	0,3	0,3	0,3	399,23	1,069	M1.90274
19	100	6	0,6	0,6	0,6	0,6	398,46	3,142	M1.90175

1. Profile standardowe | Standard profiles | Standardprofile

1.2. Kątowniki nierównoramienne

Non equal - L profiles
Winkelprofile Ungleichschenkelig

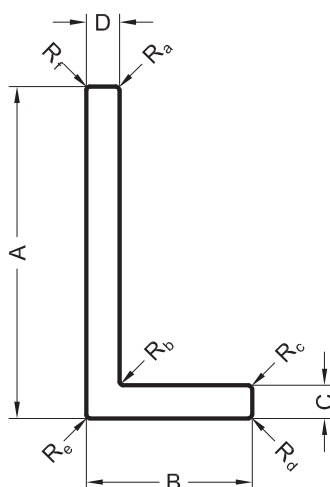

Lp.	Wymiar Dimension Abmessung				Promień Radius Radius						Obwód Perimeter Abwicklung	Masa Weight Gewicht	Nr matrycy Number of die Werkzeug Nr.
	A	B	C	D	Ra	Rb	Rc	Rd	Re	Rf	mm	kg/m	
1	30	20	1,5	1,5	0,3	0,3	0,3	0,3	0,3	0,3	99,23	0,196	M1.90337
2	30	20	2	2	0,5	0,5	0,5	0,5	0,5	0,5	98,71	0,259	M1.90055
3	30	20	4	4	0,3	0,3	0,3	0,3	0,3	0,3	99,23	0,497	M1.90423
4	35	25	3	3	0,3	0,3	0,3	0,3	0,3	0,3	119,23	0,462	M1.90120
5	40	10	2	2	0,5	0,5	0,5	0,5	0,5	0,5	98,71	0,259	M1.90371
6	40	18	5	5	0,5	0,5	0,5	0,5	0,5	0,5	114,71	0,715	M1.90206
7	40	20	2	2	0,5	0,5	0,5	0,5	0,5	0,5	118,71	0,313	M1.90009
8	40	25	2	2	0,2	0,2	0,2	0,2	0,2	0,2	129,49	0,340	M1.90298
9	40	25	3	3	0,5	0,5	0,5	0,5	0,5	0,5	128,71	0,504	M1.90063
10	40	30	3	3	0,5	0,5	0,5	0,5	0,5	0,5	138,71	0,542	M1.90088
11	50	20	2	2	0,5	0,5	0,5	0,5	0,5	0,5	138,71	0,367	M1.90079
12	50	25	2	2	0,3	0,5	0,3	0,3	0,5	0,3	149,06	0,394	M1.90357
13	50	30	2	2	0,3	0,3	0,3	0,3	0,3	0,3	159,23	0,421	M1.90397
14	60	20	2	2	0,3	0,3	0,3	0,3	0,3	0,3	159,23	0,421	M1.90286
15	60	30	2	2	0,3	0,5	0,3	0,3	0,5	0,3	179,06	0,475	M1.90356
16	60	30	10	10	1,5	1,5	1,5	1,5	1,5	1,5	176,14	2,155	M1.90348
17	60	40	2	2	0,5	0,5	0,5	0,5	0,5	0,5	198,71	0,529	M1.90198
18	60	40	3	3	0,6	0,6	0,6	0,6	0,6	0,6	198,46	0,785	M1.90257
19	60	40	5	5	0,6	0,6	0,6	0,6	0,6	0,6	198,46	1,282	M1.90124
20	60	45	1,8	1,8	0,3	0,3	0,3	0,3	0,3	0,3	209,23	0,501	M1.90129

1. Profile standardowe | Standard profiles | Standardprofile

1.2. Kątowniki nierównoramienne

Non equal - L profiles

Winkelprofile Ungleichschenkelig

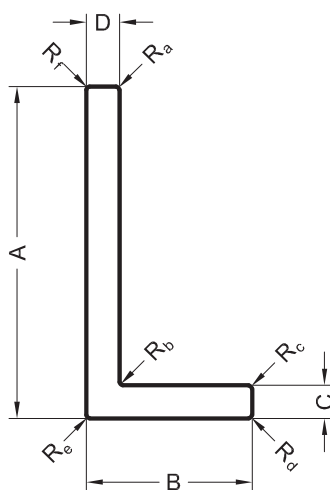

Lp.	Wymiar Dimension Abmessung				Promień Radius Radius						Obwód Perimeter Abwicklung	Masa Weight Gewicht	Nr matrycy Number of die Werkzeug Nr.
	A	B	C	D	Ra	Rb	Rc	Rd	Re	Rf	mm	kg/m	
21	60	50	3	3	0,6	0,6	0,6	0,6	0,6	0,6	218,46	0,866	M1.90234
22	65	25	2	2	0,4	0,4	0,4	0,4	0,4	0,4	178,97	0,475	M1.90398
23	65	40	3	3	0,6	0,6	0,6	0,6	0,6	0,6	208,46	0,825	M1.90148
24	80	20	2	2	0,5	0,5	0,5	0,5	0,5	0,5	198,71	0,529	M1.90394
25	80	40	1,8	1,8	0,3	0,3	0,3	0,3	0,3	0,3	239,23	0,574	M1.90362
26	80	40	2	2	0,3	0,3	0,3	0,3	0,3	0,3	239,23	0,637	M1.90407
27	80	40	3	3	0,5	0,5	0,5	0,5	0,5	0,5	238,71	0,947	M1.90304
28	80	40	4	4	0,5	0,5	0,5	0,5	0,5	0,5	238,71	1,252	M1.90170
29	80	50	3	3	0,6	0,6	0,6	0,6	0,6	0,6	258,46	1,028	M1.90235
30	80	50	6	6	0,5	0,5	0,5	0,5	0,5	0,5	258,71	2,008	M1.90176
31	100	50	3	3	0,6	0,6	0,6	0,6	0,6	0,6	298,46	1,190	M1.90142
32	100	50	6	6	0,6	0,6	0,6	0,6	0,6	0,6	298,46	2,332	M1.90316
33	100	60	2	2	0,5	0,5	0,5	0,5	0,5	0,5	318,71	0,853	M1.90205
34	120	50	3	3	0,6	0,6	0,6	0,6	0,6	0,6	338,46	1,352	M1.90143
35	140	50	3	3	0,6	0,6	0,6	0,6	0,6	0,6	378,46	1,514	M1.90144
36	160	50	3	3	0,6	0,6	0,6	0,6	0,6	0,6	418,46	1,676	M1.90145
37	180	50	3	3	0,6	0,6	0,6	0,6	0,6	0,6	458,46	1,838	M1.90086
38	200	50	3	3	0,6	0,6	0,6	0,6	0,6	0,6	498,46	2,000	M1.90236
39	220	50	3	3	0,6	0,6	0,6	0,6	0,6	0,6	538,46	2,162	M1.90237

1. Profile standardowe | Standard profiles | Standardprofile

1.3. Ceowniki

U-profiles

U-profile

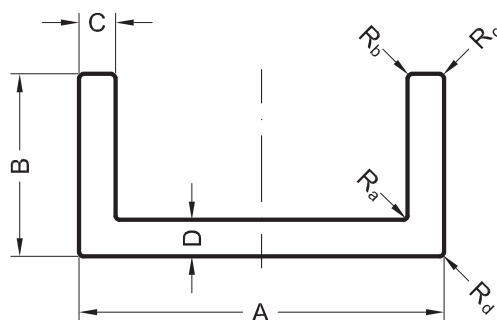

Lp.	Wymiar Dimension Abmessung				Promień Radius Radius				Obwód Perimeter Abwicklung	Masa Weight Gewicht	Nr matrycy Number of die Werkzeug Nr.
	A	B	C	D	Ra	Rb	Rc	Rd	mm	kg/m	
1	15	15	1,5	1,5	0,3	0,3	0,3	0,3	85,97	0,170	M1.90112
2	15	20	2	2	0,3	0,3	0,3	0,3	104,970	0,275	M1.90364
3	16	30	2	2	0,3	0,3	0,3	0,3	146,97	0,389	M1.90363
4	18	18	2	2	0,3	0,3	0,3	0,3	102,97	0,270	M1.90294
5	20	20	1,5	1,5	0,3	0,3	0,3	0,3	115,97	0,231	M1.90367
6	20	20	2	2	0,3	0,3	0,3	0,3	114,97	0,302	M1.90111
7	20	20	3	3	0,2	0,2	0,2	0,2	113,31	0,437	M1.90303
8	20	30	2	2	0,3	0,3	0,3	0,3	154,97	0,410	M1.90319
9	21	20	1,4	1,4	0,3	0,3	0,3	0,3	118,17	0,220	M1.90293
10	22	22	2	2	0,3	0,3	0,3	0,3	126,97	0,335	M1.90412
11	25	15	2	2	0,3	0,3	0,3	0,3	104,97	0,275	M1.90291
12	30	23	1,7	1,7	0,5	0,5	0,5	0,5	146,88	0,333	M1.90347
13	30	30	3	3	3	0,75	0,75	0,75	169,49	0,689	M1.90195
14	30	40	2,5	3	0,5	0,2	0,2	0,2	213,06	0,743	M1.90099
15	34	50	3	3	0,5	0,5	0,5	0,5	260,28	1,036	M1.90241
16	40	20	2	2	0,3	0,3	0,3	0,3	154,97	0,410	M1.90401
17	40	30	3	3	0,5	0,5	0,5	0,5	192,28	0,761	M1.90334
18	40	40	2	2	0,3	0,3	0,3	0,3	234,97	0,626	M1.90093
19	40	40	4	4	0,6	0,6	0,6	0,6	229,94	1,209	M1.90095
20	40	50	2,5	2,5	0,5	0,5	0,5	0,5	273,28	0,911	M1.90014
21	45	25	2,5	2,5	0,2	0,5	0,5	0,5	183,54	0,607	M1.90343
22	50	25	3	3	0,5	0,5	0,5	0,5	192,28	0,761	M1.90391
23	50	30	3	3	1,5	1	1	1	210,14	0,842	M1.90264

1. Profile standardowe | Standard profiles | Standardprofile

1.3. Ceowniki

U-profiles

U-profile

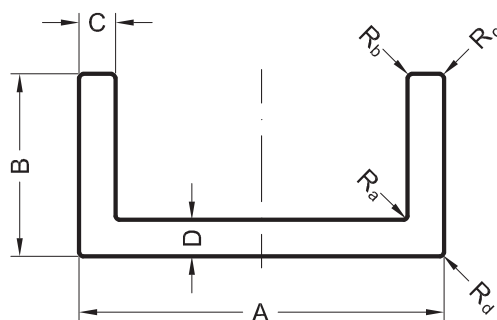

Lp.	Wymiar Dimension Abmessung				Promień Radius Radius				Obwód Perimeter Abwicklung mm	Masa Weight Gewicht kg/m	Nr matrycy Number of die Werkzeug Nr.
	A	B	C	D	Ra	Rb	Rc	Rd			
24	50	50	3	3	0,4	0,4	0,4	0,4	292,63	1,166	M1.90366
25	50	30	4	4	0,5	0,5	0,5	0,5	210,28	1,101	M1.90226
26	50	40	4	4	0,5	0,5	0,5	0,5	250,28	1,317	M1.90010
27	50	45	2	2	0,5	0,5	0,5	0,5	274,28	0,734	M1.90011
28	50	50	5	5	0,5	0,5	0,5	0,5	288,28	1,889	M1.90227
29	60	20	2	2	0,3	0,3	0,3	0,3	194,97	0,518	M1.90287
30	60	40	3	3	0,3	0,3	0,3	0,3	272,97	1,085	M1.90300
31	60	40	5	5	0,6	0,6	0,6	0,6	267,94	1,754	M1.90177
32	65	40	6	6	0,5	0,5	0,5	0,5	276,28	2,154	M1.90342
33	79	34	3,5	3,5	0,5	0,5	0,5	0,5	285,28	1,322	M1.02747
34	80	40	5	5	0,6	0,6	0,6	0,6	307,94	2,024	M1.90258
35	80	45	6	6	0,5	0,5	0,5	0,5	326,28	2,559	M1.90279
36	86	40	3	4	0,5	0,5	0,5	0,5	322,28	1,511	M1.90244
37	100	50	5	5	0,5	0,5	0,5	0,5	388,28	2,564	M1.90228
38	100	50	10	10	10	5	0,2	0,2	366,47	4,947	M1.90085
39	108	60	5	5	0,5	0,5	0,5	0,5	444,30	2,942	M1.90108
40	120	45	3	3	0,6	0,6	0,6	0,6	411,94	1,652	M1.90147
41	120	60	5	5	0,7	0,2	0,2	0,7	468,45	3,105	M1.90123
42	120	60	8	8	0,7	0,2	0,2	0,7	462,46	4,838	M1.90122
43	120	70	5	5	0,5	0,5	0,5	0,5	508,30	3,375	M1.90109
44	125	80	8	8	0,8	0,8	0,8	0,8	551,25	5,809	M1.90351
45	160	80	3	2	2	1	1	4	629,13	2,111	M1.90272

1. Profile standardowe | Standard profiles | Standardprofile

1.4. Rury okrągłe

Round tubes

Rundrohre

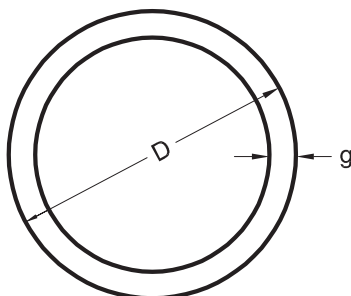

Lp.	Wymiar Dimension Abmessung		Obwód Perimeter Abwicklung mm	Masa Weight Gewicht kg/m	Nr matrycy Number of die Werkzeug Nr.
	D	g			
1	16	1,5	50,27	0,184	M1.90240
2	16	2	50,27	0,238	M1.90061
3	18	1,5	56,55	0,210	M1.90084
4	19,6	1,3	61,58	0,202	M1.90033
5	20	1	62,83	0,161	M1.90163
6	20	1,5	62,83	0,235	M1.90185
7	20	2	62,83	0,305	M1.90050
8	22	2	69,12	0,339	M1.90091
9	22	2	69,12	0,339	M1.90417
10	22,5	1,2	70,69	0,217	M1.90032
11	22,5	1,5	70,69	0,267	M1.90150
12	25	1,5	78,54	0,299	M1.90110
13	25	2	78,54	0,390	M1.90047
14	25	3	78,54	0,560	M1.90435
15	27,2	1,1	85,45	0,244	M1.90383
16	28	1	87,97	0,229	M1.90186
17	28	1,5	87,97	0,337	M1.90141
18	28	2	87,97	0,441	M1.90378
19	28	2,5	87,97	0,541	M1.90034
20	28	5	87,97	0,975	M1.90321
21	28,6	2	89,85	0,451	M1.90380

Lp.	Wymiar Dimension Abmessung		Obwód Perimeter Abwicklung mm	Masa Weight Gewicht kg/m	Nr matrycy Number of die Werkzeug Nr.
	D	g			
22	28,6	3	89,85	0,651	M1.90204
23	30	1,5	94,25	0,362	M1.90087
24	30	2	94,25	0,477	M1.90069
25	30	3	94,25	0,687	M1.90290
26	30,5	2	95,82	0,483	M1.90432
27	32	1	100,53	0,263	M1.90107
28	32	2	100,53	0,509	M1.90277
29	32	3	100,53	0,738	M1.90178
30	34	1,5	106,81	0,414	M1.90231
31	35	1,5	109,96	0,426	M1.90021
32	35	2	109,96	0,560	M1.90015
33	35	3	109,96	0,814	M1.90149
34	35,15	4,5	110,43	1,170	M1.90159
35	40	1,5	125,66	0,490	M1.90022
36	40	2	125,66	0,645	M1.90042
37	40	2,5	125,66	0,795	M1.90239
38	40	3	125,66	0,942	M1.90289
39	42	1,5	131,95	0,515	M1.90230
40	42	3,8	131,95	1,231	M1.90215
41	43	6,75	135,09	2,076	M1.90255
42	45	2	141,37	0,729	M1.90424

1. Profile standardowe | Standard profiles | Standardprofile

1.4. Rury okrągłe

Round tubes

Rundrohre

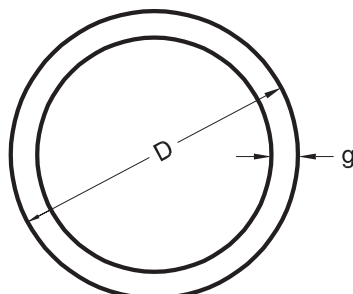

Lp.	Wymiar Dimension Abmessung		Obwód Perimeter Abwicklung mm	Masa Weight Gewicht kg/m	Nr matrycy Number of die Werkzeug Nr.
	D	g			
43	48	2	150,80	0,780	M1.90436
44	48	3	150,80	1,145	M1.90283
45	48,3	3,3	151,74	1,260	M1.90267
46	48,3	4	151,74	1,503	M1.90151
47	48,3	6	151,74	2,153	M1.90209
48	50	1,5	157,08	0,617	M1.90040
49	50	2	157,08	0,814	M1.90059
50	50	3	157,08	1,196	M1.90049
51	50	4	157,08	1,561	M1.90288
52	50	5	157,08	1,909	M1.90208
53	50	10	157,08	3,393	M1.90338
54	58	2	182,21	0,950	M1.90229
55	60	1,5	188,49	0,744	M1.90048
56	60	2	188,49	0,984	M1.90242
57	60	3	188,49	1,450	M1.90243
58	60	3,5	188,49	1,677	M1.90410
59	60	4	188,49	1,900	M1.90164
60	60	5	188,49	2,333	M1.90224
61	61	6	191,64	2,799	M1.90345
62	70	2	219,91	1,154	M1.90039

Lp.	Wymiar Dimension Abmessung		Obwód Perimeter Abwicklung mm	Masa Weight Gewicht kg/m	Nr matrycy Number of die Werkzeug Nr.
	D	g			
63	71	2	223,10	1,170	M1.00316
64	75	3,5	235,62	2,123	M1.90161
65	80	3	251,33	1,959	M1.90101
66	82	11	257,61	6,625	M1.90346
67	85	2	267,10	1,408	M1.00317
68	87,5	2	274,89	1,450	M1.90196
69	90	2	282,74	1,493	M1.90332
70	90	2,5	282,74	1,856	M1.90333
71	100	2	314,16	1,663	M1.90301
72	102	3	320,44	2,519	M1.90374
73	103,5	2	325,16	1,722	M1.90197
74	109	5	342,44	4,411	M1.00312
75	120	3	376,99	2,977	M1.90247
76	120	5	376,99	4,877	M1.90249
77	121	11	380,13	10,264	M1.00313
78	140	3	439,82	3,486	M1.90404
79	149	4,5	468,10	5,516	M1.90167
80	150	5	471,24	6,150	M1.90248
81	150	6	471,24	7,329	M1.90251
82	182	4,8	571,77	7,215	M1.90168

1. Profile standardowe | Standard profiles | Standardprofile

1.5. Rury kwadratowe

Square tubes
Quadratrohre

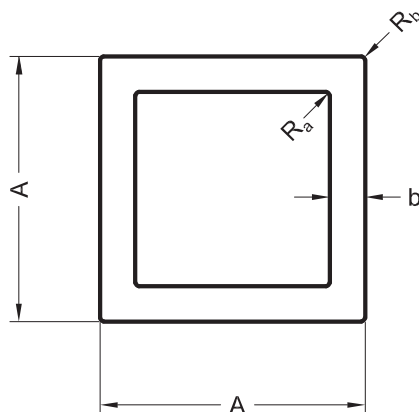

Lp.	Wymiar Dimension Abmessung		Promień Radius Radius		Obwód Perimeter Abwicklung	Masa Weight Gewicht	Nr matrycy Number of die Werkzeug Nr.
	A	b	R _a	R _b	mm	kg/m	
1	20	1,5	0,3	0,5	79,14	0,299	M1.90219
2	20	2	0,5	0,5	79,14	0,389	M1.90041
3	20	2	1	3	74,85	0,370	M1.90269
4	21,5	1,5	1	1	84,28	0,324	M1.90173
5	22	2	0,5	0,5	87,14	0,432	M1.90083
6	25	1	0,5	0,5	99,14	0,259	M1.90137
7	25	1,4	0,3	0,3	99,49	0,357	M1.90098
8	25	2	0,5	0,5	99,14	0,497	M1.90157
9	30	2	0,5	0,5	119,14	0,605	M1.90023
10	30	3	0,5	0,5	119,14	0,875	M1.90024
11	35	2	0,3	0,5	139,14	0,712	M1.90092
12	40	2	0,5	0,5	159,14	0,821	M1.90025
13	40	3	0,5	0,5	159,14	1,203	M1.90072
14	40	4	0,5	0,5	159,14	1,556	M1.90046
15	45	2	0,3	0,5	179,14	0,928	M1.90440
16	45	2,5	0,3	0,5	179,14	1,147	M1.90256
17	50	2	0,5	0,5	199,14	1,037	M1.90051
18	50	3	0,5	0,5	199,14	1,523	M1.90116
19	50	4	0,5	0,5	199,14	1,987	M1.90433
20	50	5	0,5	0,5	199,14	2,430	M1.90225

Lp.	Wymiar Dimension Abmessung		Promień Radius Radius		Obwód Perimeter Abwicklung	Masa Weight Gewicht	Nr matrycy Number of die Werkzeug Nr.
	A	b	R _a	R _b	mm	kg/m	
21	60	1,2	0,5	0,5	239,14	0,765	M1.90073
22	60	2	0,5	0,5	239,14	1,253	M1.90026
23	60	2	1	3	234,85	1,234	M1.90295
24	60	3	0,6	0,6	238,97	1,847	M1.90052
25	60	4	0,5	0,5	239,14	2,419	M1.90434
26	70	2	2	4	273,13	1,441	M1.90296
27	80	2	0,5	0,5	319,14	1,685	M1.90416
28	80	2	2	4	313,13	1,657	M1.90297
29	80	3	1	1	318,28	2,495	M1.90194
30	80	6	0,5	1	318,28	4,793	M1.90202
31	100	3	0,5	0,5	399,14	3,154	M1.02944
32	100	4	0,5	0,5	399,14	4,147	M1.90299
33	110	3	0,5	1	438,28	3,465	M1.90382
34	120	5	1	1	478,28	6,210	M1.90373
35	150	5	1	1	598,28	7,830	M1.90315

1. Profile standardowe | Standard profiles | Standardprofile

1.6. Rury prostokątne

Rectangular tubes

Vierkantrohre

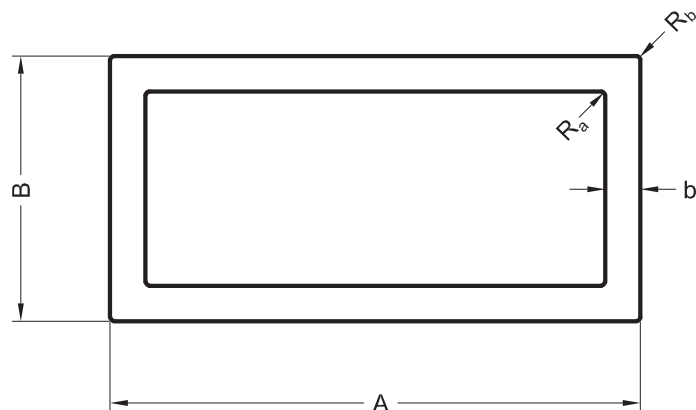

Lp.	Wymiar Dimension Abmessung			Promień Radius Radius		Obwód Perimeter Abwicklung	Masa Weight Gewicht	Nr matrycy Number of die Werkzeug Nr.
	A	B	b	Ra	Rb	mm	kg/m	
1	15	10	1,5	1	2,5	45,71	0,166	M1.90268
2	20	10	1,5	0,3	0,2	59,49	0,219	M1.90102
3	20	15	2	0,3	0,3	69,49	0,335	M1.90353
4	25	15	1,5	0,3	0,3	79,49	0,300	M1.90259
5	25	15	2	0,3	0,3	79,49	0,389	M1.90220
6	30	10	2	0,3	0,4	79,31	0,389	M1.90361
7	30	15	2	0,3	0,5	89,14	0,442	M1.90402
8	30	20	1	0,2	0,3	99,49	0,259	M1.90273
9	30	20	1	2,5	3,5	94,00	0,245	M1.90038
10	30	20	2	0,5	0,5	99,14	0,496	M1.90007
11	30	25	2	0,2	0,3	109,49	0,551	M1.90310
12	35	20	2	0,3	0,3	109,49	0,551	M1.90395
13	35	25	2	0,3	0,3	119,50	0,605	M1.90370
14	36	18	3	0,5	0,5	107,14	0,778	M1.90405
15	40	20	1,2	2,3	3,5	114,00	0,357	M1.90127
16	40	20	1,5	0,3	0,5	119,14	0,461	M1.90411
17	40	20	2	0,5	0,5	119,14	0,604	M1.90006
18	40	25	2	0,3	0,5	129,14	0,658	M1.90246
19	40	30	2	0,5	0,5	139,14	0,713	M1.90139
20	40	30	3	0,3	0,3	139,49	1,037	M1.90327
21	47,8	44,8	2	1	3	180,05	0,938	M1.04748

1. Profile standardowe | Standard profiles | Standardprofile

1.6. Rury prostokątne

Rectangular tubes

Vierkantrohre

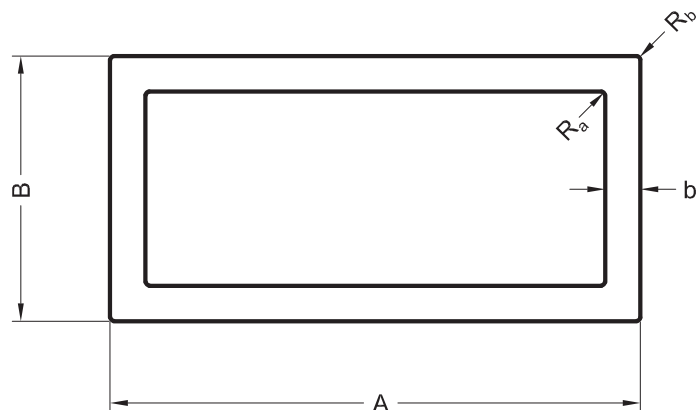

Lp.	Wymiar Dimension Abmessung			Promień Radius Radius		Obwód Perimeter Abwicklung	Masa Weight Gewicht	Nr matrycy Number of die Werkzeug Nr.
	A	B	b	Ra	Rb	mm	kg/m	
22	50	15	2	2	2	126,57	0,659	M1.90128
23	50	20	2	0,3	0,5	139,14	0,713	M1.90027
24	50	20	3	0,3	0,5	139,14	1,036	M1.90445
25	50	25	2	0,3	0,5	149,14	0,766	M1.90307
26	50	30	2	0,3	0,5	159,14	0,821	M1.90028
27	50	30	3	0,3	0,5	159,14	1,198	M1.90313
28	50	30	4	0,5	0,5	159,14	1,561	M1.90071
29	50	40	2	0,5	0,5	179,14	0,929	M1.90054
30	60	20	2	0,5	0,5	159,14	0,820	M1.90281
31	60	30	2	0,5	0,5	179,14	0,928	M1.90016
32	60	30	2	1	3	174,85	0,910	M1.90060
33	60	30	2,5	0,5	0,5	179,14	1,148	M1.90140
34	60	30	3	0,5	0,5	179,57	1,361	M1.90408
35	60	40	2	0,3	0,5	199,14	1,037	M1.90029
36	60	40	3	0,5	0,5	199,14	1,523	M1.90053
37	60	40	4	0,5	0,5	199,14	1,987	M1.90354
38	60	50	2	0,5	0,5	219,14	1,145	M1.90447
39	70	50	2	0,5	0,5	239,14	1,253	M1.90169
40	80	20	2	0,5	0,5	199,14	1,037	M1.90365
41	80	30	3	1,5	4	213,13	1,653	M1.90125
42	80	40	2	0,3	0,5	239,14	1,252	M1.90379
43	80	40	2,5	0,5	0,5	239,14	1,553	M1.90030
44	80	40	4	1,5	1	238,28	2,422	M1.90263

1. Profile standardowe | Standard profiles | Standardprofile

1.6. Rury prostokątne

Rectangular tubes
Vierkantrohre

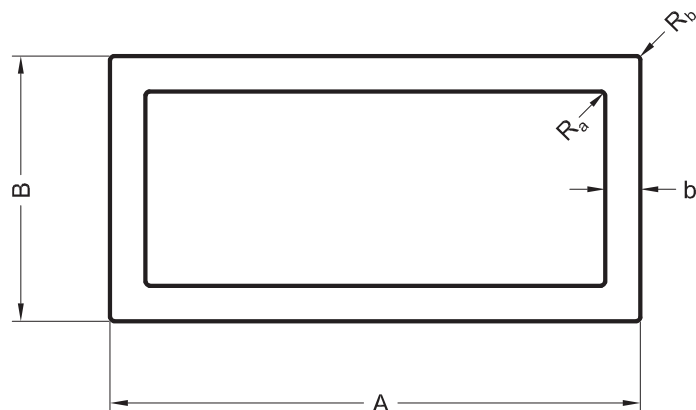

Lp.	Wymiar Dimension Abmessung			Promień Radius Radius		Obwód Perimeter Abwicklung	Masa Weight Gewicht	Nr matrycy Number of die Werkzeug Nr.
	A	B	b	Ra	Rb	mm	kg/m	
45	80	50	2	0,3	0,5	259,14	1,360	M1.90282
46	80	60	3	0,5	0,5	279,14	2,179	M1.90075
47	80	60	4	0,6	0,6	278,97	2,851	M1.90392
48	100	20	2	0,5	0,5	239,14	1,253	M1.90106
49	100	40	2	0,6	1	278,28	1,467	M1.90439
50	100	40	4	0,5	0,5	279,14	2,851	M1.90409
51	100	50	2	0,3	0,3	299,49	1,577	M1.90326
52	100	50	3	0,3	0,3	299,49	2,333	M1.90325
53	100	60	3	0,6	0,6	318,97	2,495	M1.90080
54	100	60	3	2	5	311,42	2,446	M1.90238
55	100	80	3	0,6	1	358,28	2,817	M1.90393
56	120	15	2	0,6	1	268,28	1,413	M1.90438
57	120	20	2	0,6	1	278,28	1,467	M1.90369
58	120	30	2	0,6	1	298,28	1,575	M1.90415
59	120	40	2	0,6	1	318,28	1,683	M1.90427
60	120	60	3	0,6	1	358,28	2,817	M1.90414
61	120	60	6	0,6	0,6	359,00	5,443	M1.90076
62	150	100	4	1	2	496,57	5,220	M1.90425
63	180	40	4	1	1	438,28	4,579	M1.90349
64	200	50	4	0,5	1	498,28	5,225	M1.90284
65	200	100	4	0,6	0,6	598,97	6,307	M1.90320

1. Profile standardowe | Standard profiles | Standardprofile

1.7. Pręty prostokątne

Flat bars
Flachprofile

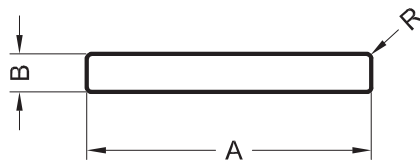

Lp.	Wymiar Dimension Abmessung			Obwód Perimeter Abwicklung	Masa Weight Gewicht	Nr matrycy Number of die Werkzeug Nr.
	A	B	R	mm	kg/m	
1	15	5	0,2	39,66	0,203	M1.90044
2	17	4	0,2	41,66	0,184	M1.90275
3	18	7	0,2	49,66	0,340	M1.90117
4	20	3	0,2	45,70	0,162	M1.90115
5	20	5	0,3	49,49	0,270	M1.90400
6	20	10	0,3	59,49	0,540	M1.90045
7	25	2	0,25	53,57	0,135	M1.90261
8	25	3	0,2	55,66	0,202	M1.90077
9	25	4	0,3	57,49	0,270	M1.90104
10	25	5	0,5	59,14	0,338	M1.90406
11	25	7	0,2	63,66	0,472	M1.90118
12	25	8	0,2	65,66	0,540	M1.90136
13	30	2	0,2	63,67	0,162	M1.90187
14	30	3	0,2	65,66	0,243	M1.90285
15	30	4	0,3	67,49	0,324	M1.90358
16	30	5	0,5	69,14	0,404	M1.90188
17	30	8	0,5	75,14	0,647	M1.90096
18	30	10	0,2	79,66	0,810	M1.90119
19	35	4	0,3	77,49	0,378	M1.90270
20	40	2	0,2	83,67	0,216	M1.90189
21	40	3	1	84,28	0,322	M1.90154
22	40	4	0,3	87,49	0,432	M1.90341
23	40	5	0,3	89,49	0,540	M1.90318
24	40	6	1	90,28	0,646	M1.90399
25	40	8	0,3	95,49	0,864	M1.90245
26	40	10	0,3	99,49	1,080	M1.90317
27	40	20	0,5	119,14	2,116	M1.90156
28	50	2	0,2	103,67	0,270	M1.90190
29	50	3	0,3	105,49	0,405	M1.90308
30	50	5	0,3	109,49	0,675	M1.90323

1. Profile standardowe | Standard profiles | Standardprofile

1.7. Pręty prostokątne

Flat bars
Flachprofile

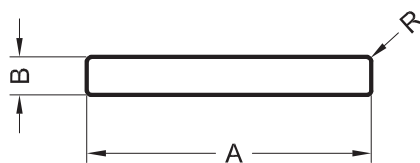

Lp.	Wymiar Dimension Abmessung			Obwód Perimeter Abwicklung	Masa Weight Gewicht	Nr matrycy Number of die Werkzeug Nr.
	A	B	R	mm	kg/m	
31	50	6	0,5	111,14	0,809	M1.90413
32	50	8	0,3	115,49	1,080	M1.90324
33	50	10	0,5	119,14	1,349	M1.90191
34	50	20	2	136,57	2,691	M1.90442
35	55	4	0,2	117,66	0,594	M1.90216
36	57	6	0,2	125,66	0,923	M1.90368
37	60	5	0,3	129,49	0,810	M1.90192
38	60	7	1	132,28	1,132	M1.90210
39	60	8	0,2	135,70	1,296	M1.90008
40	60	10	0,3	139,49	1,620	M1.90152
41	60	20	0,5	159,14	3,239	M1.90213
42	70	5	0,3	149,49	0,945	M1.90340
43	70	10	0,5	159,14	1,889	M1.90266
44	72,5	5	0,5	154,14	0,978	M1.90372
45	80	5	0,2	169,66	1,080	M1.90306
46	80	8	0,5	175,14	1,727	M1.90193
47	80	10	0,5	179,14	2,159	M1.90017
48	80	15	0,5	189,14	3,239	M1.90311
49	90	15	0,3	209,49	3,645	M1.90254
50	100	2	0,3	203,49	0,540	M1.90314
51	100	3	0,3	205,49	0,810	M1.90309
52	100	10	0,5	219,14	2,699	M1.90018
53	100	15	0,5	229,14	4,049	M1.90260
54	120	4	0,3	247,49	1,296	M1.90302
55	120	10	0,3	259,49	3,240	M1.90153
56	120	12	0,5	263,14	3,887	M1.90322
57	150	10	0,5	319,14	4,049	M1.90292
58	160	8	0,5	335,14	3,455	M1.90203
59	180	8	2	372,57	3,879	M1.90396
60	180	10	0,5	379,14	4,859	M1.90200
61	195	2,5	1	393,28	1,314	M1.90336

1. Profile standardowe | Standard profiles | Standardprofile

1.8. Pręty okrągłe

Round bars
Rundstangen

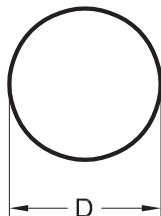

Lp.	Wymiar Dimension Abmessung	Obwód Perimeter Abwicklung	Masa Weight Gewicht	Nr matrycy Number of die Werkzeug Nr.
	D	mm	kg/m	
1	9,6	30,16	0,195	M1.90271
2	10	31,42	0,212	M1.90074
3	14	43,98	0,416	M1.90329
4	16	50,27	0,543	M1.90330
5	18	56,55	0,687	M1.90135
6	25	78,54	1,325	M1.90305
7	26	81,68	1,434	M1.90339
8	28	87,96	1,667	M1.90221
9	30	94,25	1,909	M1.90419
10	30	94,25	1,909	M1.90446 (6082)
11	35	109,96	2,598	M1.90420
12	40	125,66	3,393	M1.90418
13	50	157,08	5,301	M1.90421

1.9. Pręty kwadratowe

Square bars
Vierkantstange

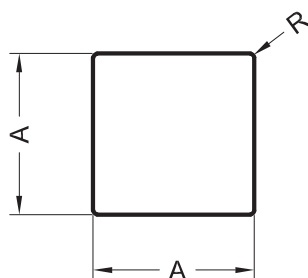

Lp.	Wymiar Dimension Abmessung	Obwód Perimeter Abwicklung	Masa Weight Gewicht	Nr matrycy Number of die Werkzeug Nr.	
	A x A	R	mm	kg/m	
1	15 x 15	0,5	59,14	0,607	M1.90201
2	20 x 20	0,5	79,14	1,079	M1.90043
3	25 x 25	2	96,57	1,678	M1.90441
4	30 x 30	0,5	119,14	2,429	M1.90214
5	40 x 40	0,3	159,49	4,320	M1.90166

1. Profile standardowe | Standard profiles | Standardprofile

1.10. Teowniki

T-profiles

T-profile

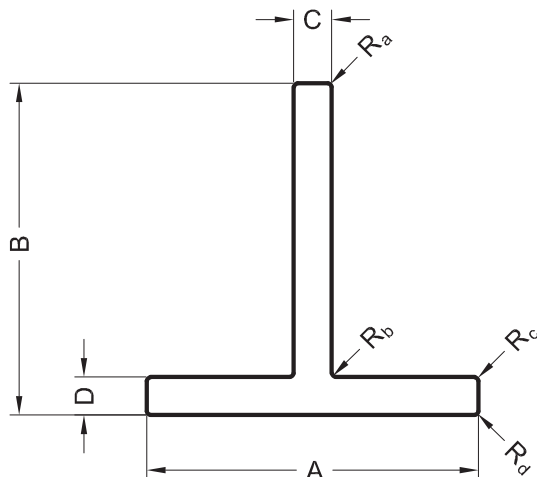

Lp.	Wymiar Dimension Abmessung				Promień Radius Radius				Obwód Perimeter Abwicklung	Masa Weight Gewicht	Nr matrycy Number of die Werkzeug Nr.
	A	B	C	D	Ra	Rb	Rc	Rd	mm	kg/m	
1	40	40	4	4	0,5	0,5	0,5	0,5	158,28	0,820	M1.90444
2	60	50	2,5	2,5	0,5	1	0,5	0,5	217,85	0,726	M1.90126
3	65	50	2	2	0,3	0,5	0,3	0,3	228,80	0,611	M1.90056
4	80	43	2,5	2	0,5	0,5	0,5	0,5	244,28	0,711	M1.90064
5	80	43	2,7	2	0,2	1	0,2	0,2	244,63	0,732	M1.90262
6	100	50	2	2	0,5	0,5	0,5	0,5	298,28	0,799	M1.90012
7	110	50	2	2	0,3	1	0,3	0,3	318,37	0,854	M1.90121
8	120	60	2	2	0,3	0,3	0,3	0,3	358,97	0,961	M1.90250

2. Profile specjalne | Special sections | Sonderprofile

2.1. Profile reklamowe

Profiles for advertising | Profile für die Lichtwerbung

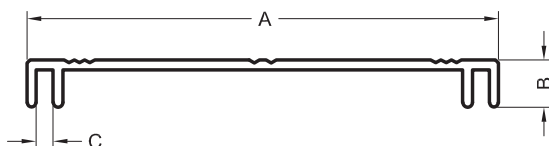

Wymiar Dimension Abmessung	Obwód Perimeter Abwicklung	Masa Weight Gewicht	Nr matrycy Number of die Werkzeug Nr.
A x B x C	mm	kg/m	
100 x 10 x 3,5	267,05	0,627	M1.90037

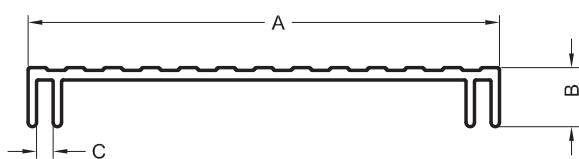

Wymiar Dimension Abmessung	Obwód Perimeter Abwicklung	Masa Weight Gewicht	Nr matrycy Number of die Werkzeug Nr.
A x B x C	mm	kg/m	
100 x 12,5 x 3,5	288,50	0,813	M1.90155

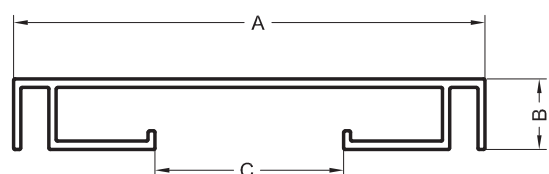

Wymiar Dimension Abmessung	Obwód Perimeter Abwicklung	Masa Weight Gewicht	Nr matrycy Number of die Werkzeug Nr.
A x B x C	mm	kg/m	
100 x 15 x 40	398,91	0,922	M1.90232

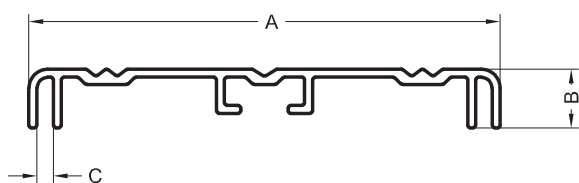

Wymiar Dimension Abmessung	Obwód Perimeter Abwicklung	Masa Weight Gewicht	Nr matrycy Number of die Werkzeug Nr.
A x B x C	mm	kg/m	
100 x 12,5 x 3,5	332,54	0,817	M1.90253

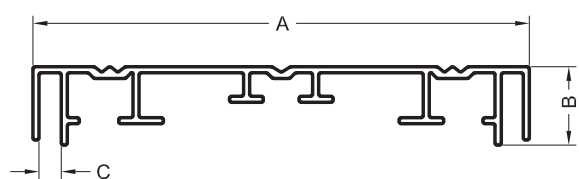

Wymiar Dimension Abmessung	Obwód Perimeter Abwicklung	Masa Weight Gewicht	Nr matrycy Number of die Werkzeug Nr.
A x B x C	mm	kg/m	
139 x 22 x 6,2	610,35	1,553	M1.90172
139 x 22 x 6,2	612,82	1,476	M1.90278

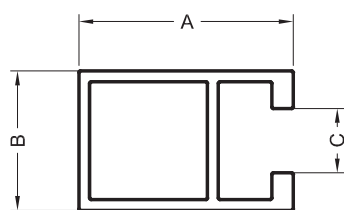

Wymiar Dimension Abmessung	Obwód Perimeter Abwicklung	Masa Weight Gewicht	Nr matrycy Number of die Werkzeug Nr.
A x B x C	mm	kg/m	
30 x 19,5 x 9	133,97	0,437	M1.90146

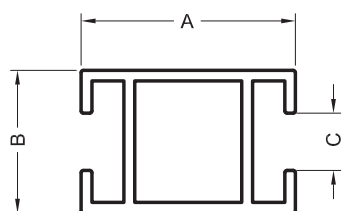

Wymiar Dimension Abmessung	Obwód Perimeter Abwicklung	Masa Weight Gewicht	Nr matrycy Number of die Werkzeug Nr.
A x B x C	mm	kg/m	
30 x 20 x 8	158,45	0,453	M1.90165

2. Profile specjalne | Special sections | Sonderprofile

2.1. Profile reklamowe

Profiles for advertising | Profile für die Lichtwerbung

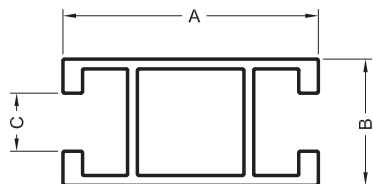

Wymiar Dimension Abmessung	Obwód Perimeter Abwicklung	Masa Weight Gewicht	Nr matrycy Number of die Werkzeug Nr.
A x B x C	mm	kg/m	
39,5 x 19,5 x 9	186,3	0,584	M1.90090

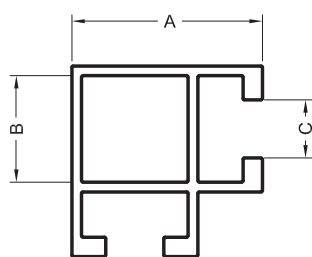

Wymiar Dimension Abmessung	Obwód Perimeter Abwicklung	Masa Weight Gewicht	Nr matrycy Number of die Werkzeug Nr.
A x B x C	mm	kg/m	
29,5 x 16,5 x 9	186,11	0,575	M1.90233

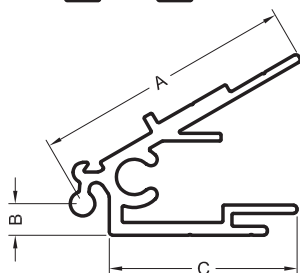

Wymiar Dimension Abmessung	Obwód Perimeter Abwicklung	Masa Weight Gewicht	Nr matrycy Number of die Werkzeug Nr.
A x B x C	mm	kg/m	
40,4 x 4,9 x 29,1	218,67	0,547	M1.90130

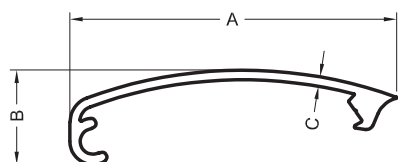

Wymiar Dimension Abmessung	Obwód Perimeter Abwicklung	Masa Weight Gewicht	Nr matrycy Number of die Werkzeug Nr.
A x B x C	mm	kg/m	
50,5 x 14,65 x 1,5	138,91	0,308	M1.90131

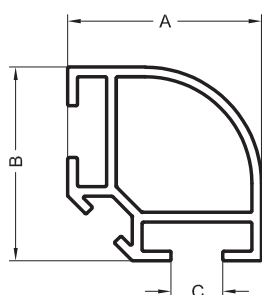

Wymiar Dimension Abmessung	Obwód Perimeter Abwicklung	Masa Weight Gewicht	Nr matrycy Number of die Werkzeug Nr.
A x B x C	mm	kg/m	
30 x 30 x 8	179,18	0,522	M1.90138

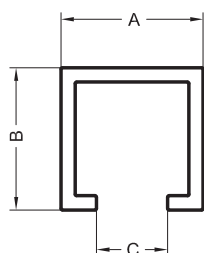

Wymiar Dimension Abmessung	Obwód Perimeter Abwicklung	Masa Weight Gewicht	Nr matrycy Number of die Werkzeug Nr.
A x B x C	mm	kg/m	
20 x 20 x 10	126,97	0,335	M1.90280

2. Profile specjalne | Special sections | Sonderprofile

2.2. Profile do płyt poliwęglanowych

Profiles for polycarbonates | Profile zu Konstruktionen mit Polykarbonat

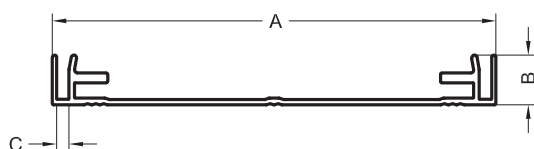
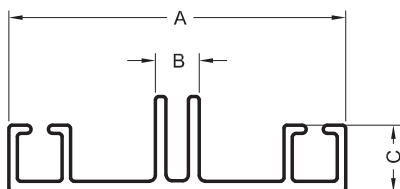
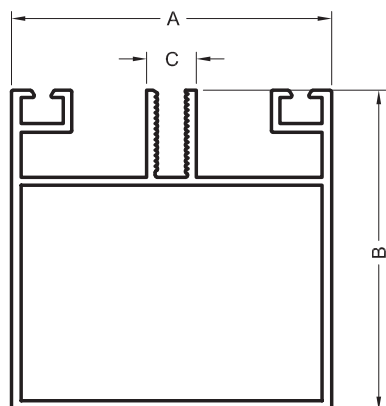
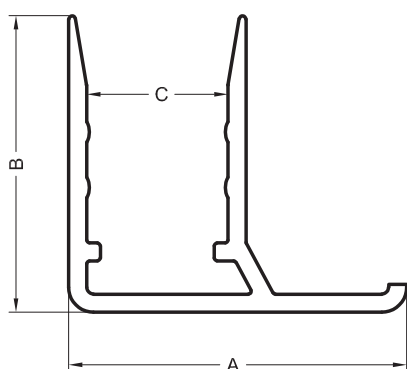
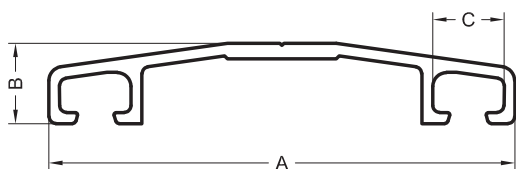

Wymiar Dimension Abmessung	Obwód Perimeter Abwicklung	Masa Weight Gewicht	Nr matrycy Number of die Werkzeug Nr.
A x B x C	mm	kg/m	
60 x 9 x 8	176,50	0,388	M1.90035
60 x 9 x 8	182,18	0,388	M1.90359

Wymiar Dimension Abmessung	Obwód Perimeter Abwicklung	Masa Weight Gewicht	Nr matrycy Number of die Werkzeug Nr.
A x B x C	mm	kg/m	
20,4 x 21,4 x 6,2	125,70	0,212	M1.90179
22,4 x 21,4 x 8,2	131,70	0,222	M1.90180
24,2 x 21,5 x 10,2	136,13	0,266	M1.90036
24,4 x 21,4 x 10,2	133,88	0,226	M1.90160
30,4 x 21,4 x 16,2	145,60	0,247	M1.90181
34,4 x 21,4 x 20,2	158,89	0,270	M1.90182

Wymiar Dimension Abmessung	Obwód Perimeter Abwicklung	Masa Weight Gewicht	Nr matrycy Number of die Werkzeug Nr.
A x B x C	mm	kg/m	
60 x 60 x 9,3	433,65	1,419	M1.90089

Wymiar Dimension Abmessung	Obwód Perimeter Abwicklung	Masa Weight Gewicht	Nr matrycy Number of die Werkzeug Nr.
A x B x C	mm	kg/m	
60 x 7,8 x 11,9	275,42	0,666	M1.90132
60 x 8 x 12	273,221	0,659	M1.90335

Wymiar Dimension Abmessung	Obwód Perimeter Abwicklung	Masa Weight Gewicht	Nr matrycy Number of die Werkzeug Nr.
A x B x C	mm	kg/m	
160 x 18 x 4,5	495,22	1,390	M1.90350

2. Profile specjalne | Special sections | Sonderprofile

2.3. Profile do central klimatyzacyjnych

Profiles for air conditioning | Klimazentralenprofile

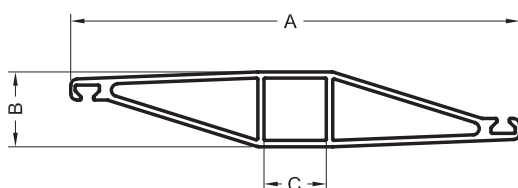
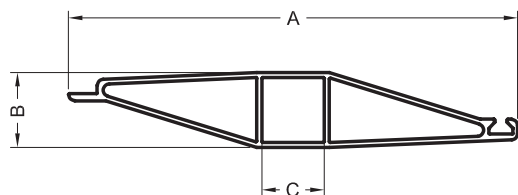
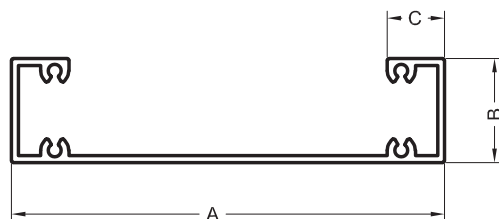
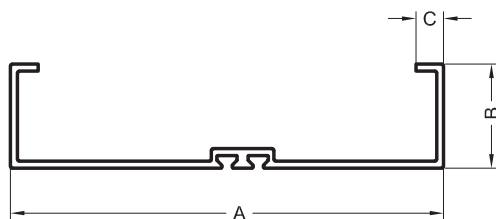
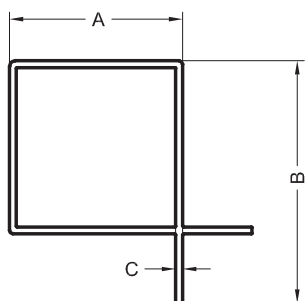
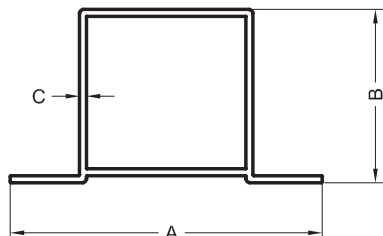

Wymiar Dimension Abmessung	Obwód Perimeter Abwicklung	Masa Weight Gewicht	Nr matrycy Number of die Werkzeug Nr.
A x B x C	mm	kg/m	
70 x 28,5 x 1,5	198,28	0,611	M1.90212
90 x 50 x 2	281,51	1,251	M1.90057
90 x 50 x 1,5	280,68	0,945	M1.90133

Wymiar Dimension Abmessung	Obwód Perimeter Abwicklung	Masa Weight Gewicht	Nr matrycy Number of die Werkzeug Nr.
A x B x C	mm	kg/m	
30 x 50 x 1,5	198,28	0,623	M1.90211
50 x 70 x 2	277,73	1,250	M1.90058
50 x 70 x 1,5	277,21	0,945	M1.90134

Wymiar Dimension Abmessung	Obwód Perimeter Abwicklung	Masa Weight Gewicht	Nr matrycy Number of die Werkzeug Nr.
A x B x C	mm	kg/m	
125 x 30 x 8	416,20	1,127	M1.90081

Wymiar Dimension Abmessung	Obwód Perimeter Abwicklung	Masa Weight Gewicht	Nr matrycy Number of die Werkzeug Nr.
A x B x C	mm	kg/m	
125 x 30 x 16,6	491,43	1,354	M1.90082

Wymiar Dimension Abmessung	Obwód Perimeter Abwicklung	Masa Weight Gewicht	Nr matrycy Number of die Werkzeug Nr.
A x B x C	mm	kg/m	
108 x 18 x 15	237,70	0,823	M1.90100

Wymiar Dimension Abmessung	Obwód Perimeter Abwicklung	Masa Weight Gewicht	Nr matrycy Number of die Werkzeug Nr.
A x B x C	mm	kg/m	
108 x 18 x 15,2	248,20	1,035	M1.90097

2. Profile specjalne | Special sections | Sonderprofile

2.4. Profile do zabudów samochodowych

Profiles for trailers, semi-trailers | Fahrzeugbauprofile

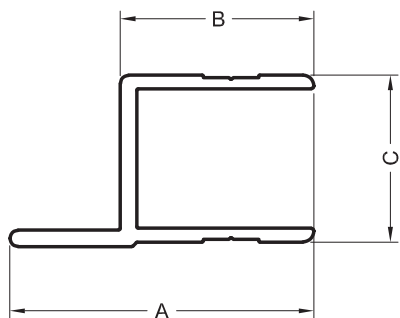

Wymiar Dimension Abmessung	Obwód Perimeter Abwicklung	Masa Weight Gewicht	Nr matrycy Number of die Werkzeug Nr.
A x B x C	mm	kg/m	
55 x 35 x 30,2	233,20	0,811	M1.90065

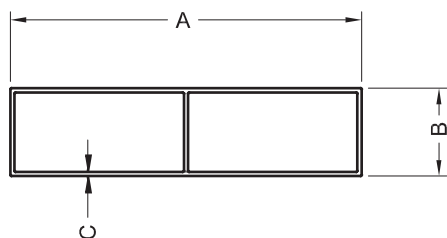

Wymiar Dimension Abmessung	Obwód Perimeter Abwicklung	Masa Weight Gewicht	Nr matrycy Number of die Werkzeug Nr.
A x B x C	mm	kg/m	
100 x 25 x 1,2	246,57	0,860	M1.90066

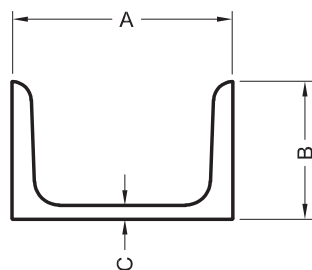

Wymiar Dimension Abmessung	Obwód Perimeter Abwicklung	Masa Weight Gewicht	Nr matrycy Number of die Werkzeug Nr.
A x B x C	mm	kg/m	
80 x 50 x 5	333,90	2,961	M1.90067

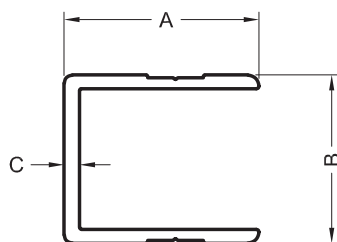

Wymiar Dimension Abmessung	Obwód Perimeter Abwicklung	Masa Weight Gewicht	Nr matrycy Number of die Werkzeug Nr.
A x B x C	mm	kg/m	
35 x 30,2 x 2,8	193,30	0,630	M1.90068

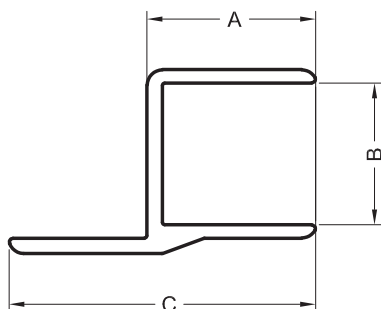

Wymiar Dimension Abmessung	Obwód Perimeter Abwicklung	Masa Weight Gewicht	Nr matrycy Number of die Werkzeug Nr.
A x B x C	mm	kg/m	
22 x 18,5 x 40	162,29	0,423	M1.90158

2. Profile specjalne | Special sections | Sonderprofile

2.4. Profile do zabudów samochodowych

Profiles for trailers, semi-trailers | Fahrzeugbauprofile

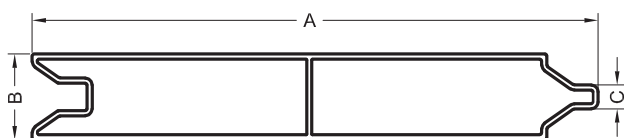
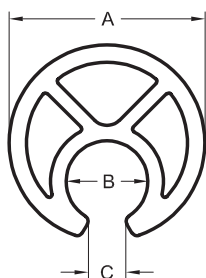
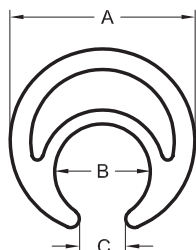

Wymiar Dimension Abmessung	Obwód Perimeter Abwicklung	Masa Weight Gewicht	Nr matrycy Number of die Werkzeug Nr.
A x B x C	mm	kg/m	
27 x 14 x 6,7	117,56	0,728	M1.90183
27 x 14 x 7	116,64	0,592	M1.90428

Wymiar Dimension Abmessung	Obwód Perimeter Abwicklung	Masa Weight Gewicht	Nr matrycy Number of die Werkzeug Nr.
A x B x C	mm	kg/m	
34 x 14,2 x 6,5	141,82	1,156	M1.90223

Wymiar Dimension Abmessung	Obwód Perimeter Abwicklung	Masa Weight Gewicht	Nr matrycy Number of die Werkzeug Nr.
A x B x C	mm	kg/m	
165 x 25 x 7	393,81	1,657	M1.90184

2.5. Profile elewacyjne

Elevation profiles | Elevationsprofile

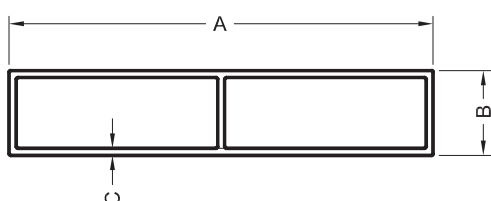
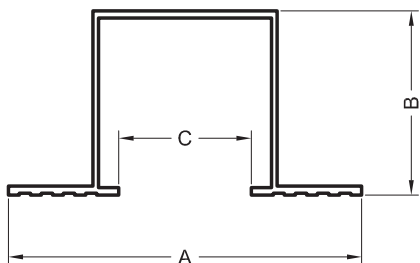

Wymiar Dimension Abmessung	Obwód Perimeter Abwicklung	Masa Weight Gewicht	Nr matrycy Number of die Werkzeug Nr.
A x B x C	mm	kg/m	
96 x 50 x 36	419,34	0,971	M1.90013

Wymiar Dimension Abmessung	Obwód Perimeter Abwicklung	Masa Weight Gewicht	Nr matrycy Number of die Werkzeug Nr.
A x B x C	mm	kg/m	
90 x 18 x 1,5	215,49	0,912	M1.90103
200 x 20 x 2,0	439,14	2,419	M1.90381

2. Profile specjalne | Special sections | Sonderprofile

2.6. Profile fotowoltaiczne

Profiles for photovoltaics | Profile für die photovoltaik

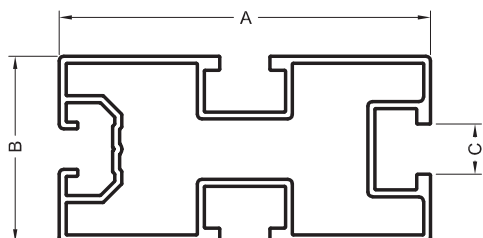

Wymiar Dimension Abmessung	Obwód Perimeter Abwicklung	Masa Weight Gewicht	Nr matrycy Number of die Werkzeug Nr.
A x B x C	mm	kg/m	
80 x 40 x 10,8	400,41	1,546	M1.90174

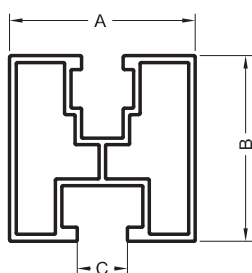

Wymiar Dimension Abmessung	Obwód Perimeter Abwicklung	Masa Weight Gewicht	Nr matrycy Number of die Werkzeug Nr.
A x B x C	mm	kg/m	
40 x 40 x 10,8	238,91	0,938	M1.90222
40 x 40 x 10,8	238,91	0,891	M1.90331

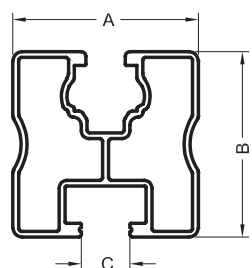

Wymiar Dimension Abmessung	Obwód Perimeter Abwicklung	Masa Weight Gewicht	Nr matrycy Number of die Werkzeug Nr.
A x B x C	mm	kg/m	
40 x 40 x 10,5	237,91	0,838	M1.90352
40 x 40 x 10,5	237,91	0,799	M1.90403

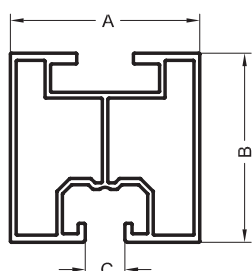

Wymiar Dimension Abmessung	Obwód Perimeter Abwicklung	Masa Weight Gewicht	Nr matrycy Number of die Werkzeug Nr.
A x B x C	mm	kg/m	
40 x 40 x 8,4	247,62	0,847	M1.90429

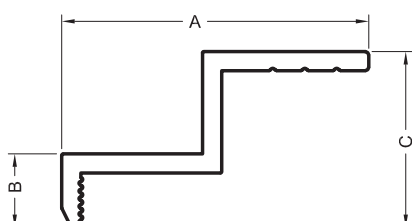

Wymiar Dimension Abmessung	Obwód Perimeter Abwicklung	Masa Weight Gewicht	Nr matrycy Number of die Werkzeug Nr.
A x B x C	mm	kg/m	
48 x 11,5 x 27,5	154,63	0,579	M1.90265
37,8 x 10,8 x 26,8	131,22	0,467	M1.90376

2. Profile specjalne | Special sections | Sonderprofile

2.6. Profile fotowoltaiczne

Profiles for photovoltaics | Profile für die photovoltaik

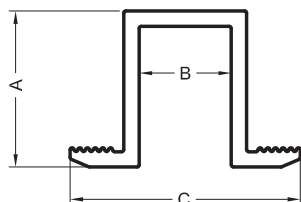

Wymiar Dimension Abmessung	Obwód Perimeter Abwicklung	Masa Weight Gewicht	Nr matrycy Number of die Werkzeug Nr.
A x B x C	mm	kg/m	
24,4 x 14,4 x 36	170,10	0,519	M1.90377

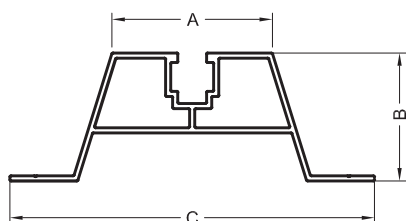

Wymiar Dimension Abmessung	Obwód Perimeter Abwicklung	Masa Weight Gewicht	Nr matrycy Number of die Werkzeug Nr.
A x B x C	mm	kg/m	
50 x 40 x 114	348,22	1,202	M1.90385
50 x 70 x 114	420,50	1,672	M1.90384

2.7. Profile do hal namiotowych

Profiles for tents | Zeltbauprofile

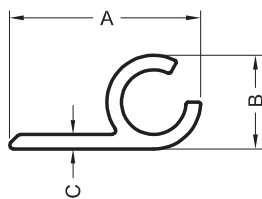

Wymiar Dimension Abmessung	Obwód Perimeter Abwicklung	Masa Weight Gewicht	Nr matrycy Number of die Werkzeug Nr.
A x B x C	mm	kg/m	
26,5 x 13 x 2	91,17	0,244	M1.90355

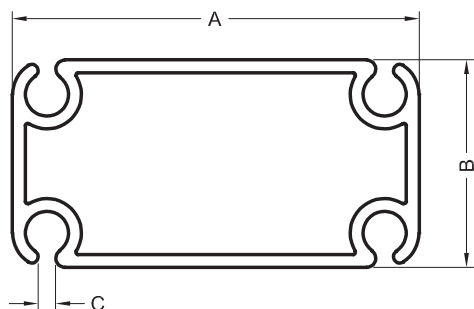

Wymiar Dimension Abmessung	Obwód Perimeter Abwicklung	Masa Weight Gewicht	Nr matrycy Number of die Werkzeug Nr.
A x B x C	mm	kg/m	
94 x 48 x 4	378,00	2,665	M1.90312
150 x 88 x 7	640,10	4,601	M1.90252

2. Profile specjalne | Special sections | Sonderprofile

2.8. Profile inne

Other profiles | Andere Profile

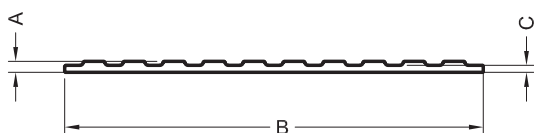

Wymiar Dimension Abmessung	Obwód Perimeter Abwicklung	Masa Weight Gewicht	Nr matrycy Number of die Werkzeug Nr.
A x B x C	mm	kg/m	
3 x 115,1 x 1,9	246,21	0,775	M1.90113

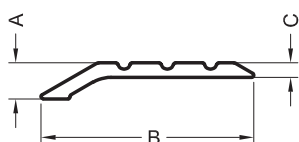

Wymiar Dimension Abmessung	Obwód Perimeter Abwicklung	Masa Weight Gewicht	Nr matrycy Number of die Werkzeug Nr.
A x B x C	mm	kg/m	
5 x 29,5 x 2	64,74	0,143	M1.90114

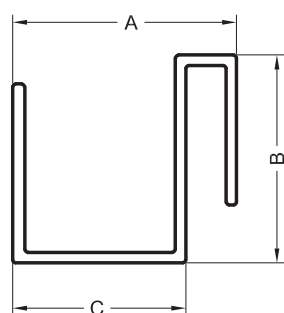

Wymiar Dimension Abmessung	Obwód Perimeter Abwicklung	Masa Weight Gewicht	Nr matrycy Number of die Werkzeug Nr.
A x B x C	mm	kg/m	
38,8 x 36 x 30	253,83	0,637	M1.90207

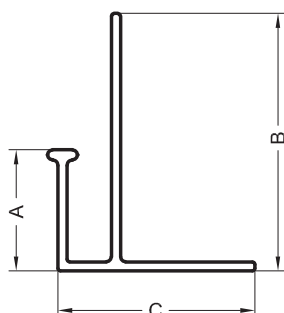

Wymiar Dimension Abmessung	Obwód Perimeter Abwicklung	Masa Weight Gewicht	Nr matrycy Number of die Werkzeug Nr.
A x B x C	mm	kg/m	
24 x 51 x 39	227,99	0,559	M1.90217

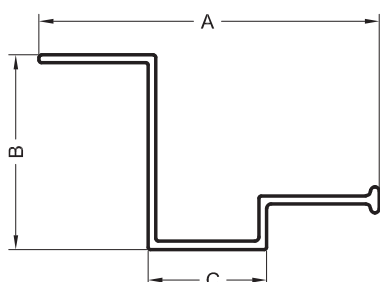

Wymiar Dimension Abmessung	Obwód Perimeter Abwicklung	Masa Weight Gewicht	Nr matrycy Number of die Werkzeug Nr.
A x B x C	mm	kg/m	
78,6 x 45 x 27,4	271,16	0,679	M1.90218

2. Profile specjalne | Special sections | Sonderprofile

2.8. Profile inne

Other profiles | Andere Profile

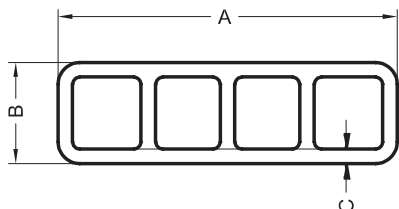

Wymiar Dimension Abmessung	Obwód Perimeter Abwicklung	Masa Weight Gewicht	Nr matrycy Number of die Werkzeug Nr.
A x B x C	mm	kg/m	
47 x 14 x 2	116,85	0,766	M1.90344

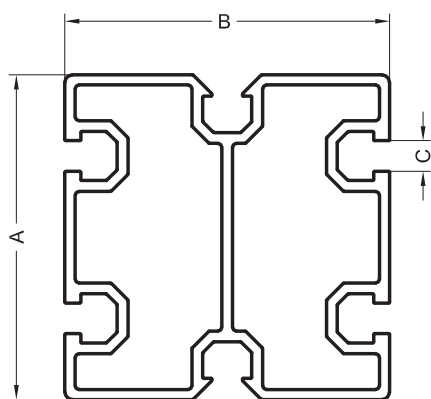

Wymiar Dimension Abmessung	Obwód Perimeter Abwicklung	Masa Weight Gewicht	Nr matrycy Number of die Werkzeug Nr.
A x B x C	mm	kg/m	
90 x 90 x 8,5	561,32	4,617	M1.90360

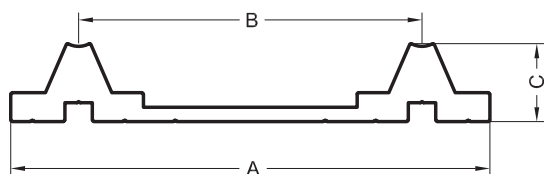

Wymiar Dimension Abmessung	Obwód Perimeter Abwicklung	Masa Weight Gewicht	Nr matrycy Number of die Werkzeug Nr.
A x B x C	mm	kg/m	
166 x 119 x 27	433,97	4,547	M1.90422

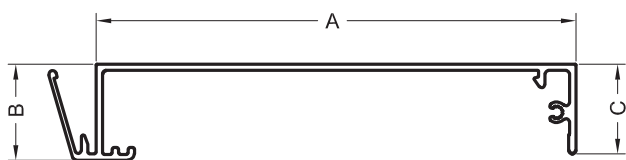

Wymiar Dimension Abmessung	Obwód Perimeter Abwicklung	Masa Weight Gewicht	Nr matrycy Number of die Werkzeug Nr.
A x B x C	mm	kg/m	
150 x 30 x 28	553,95	1,380	M1.90443

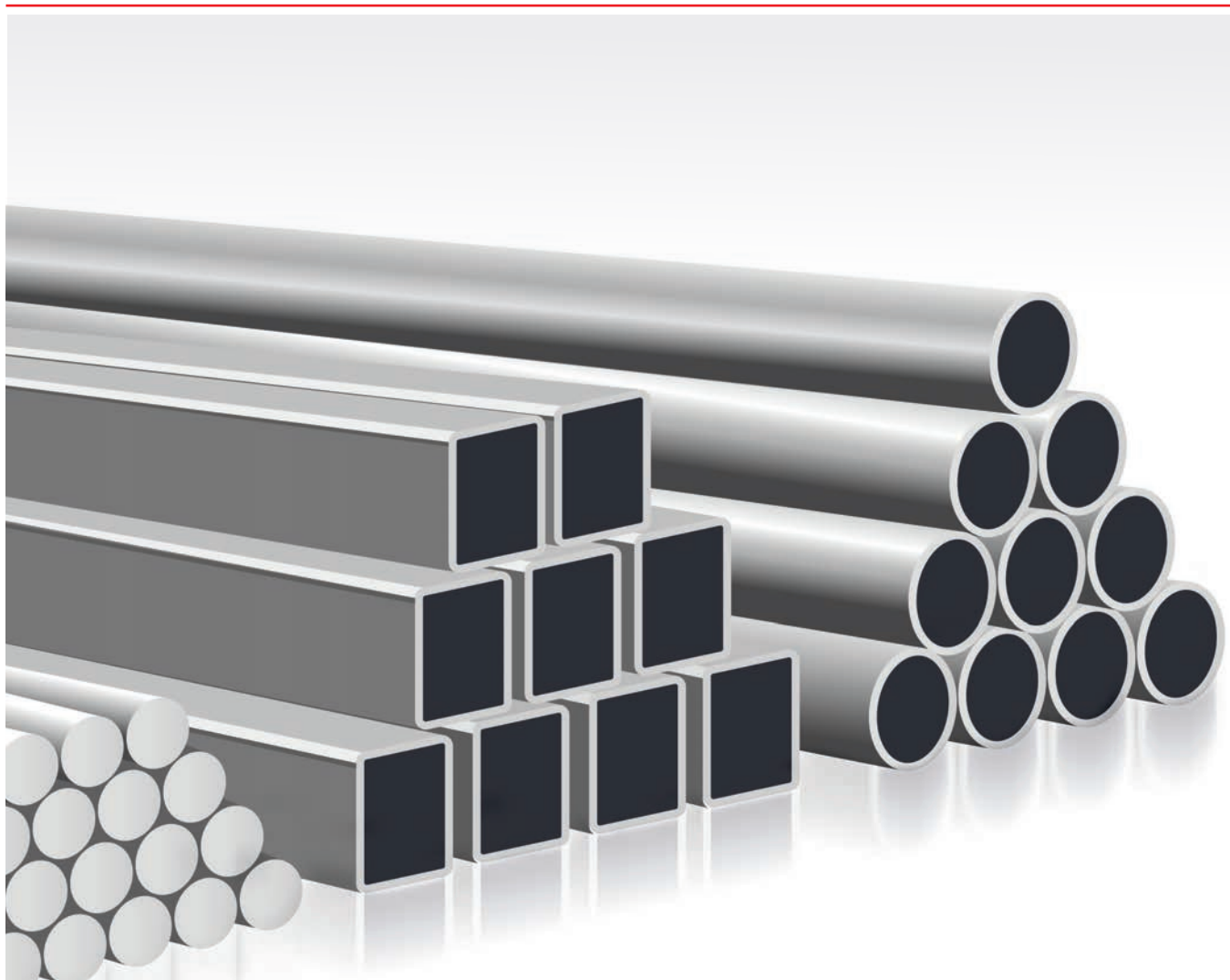

aliplast
aluminium extrusion

Aliplast Extrusion Sp. z o.o.
ul. Wacława Moritza 3
20-276 Lublin, Polska

Kontakt

t: +48 81 710 68 00
e: extrusion@aliplast.pl

www.aliplastextrusion.pl



01.2024



www.corialis-group.com